

GRADE

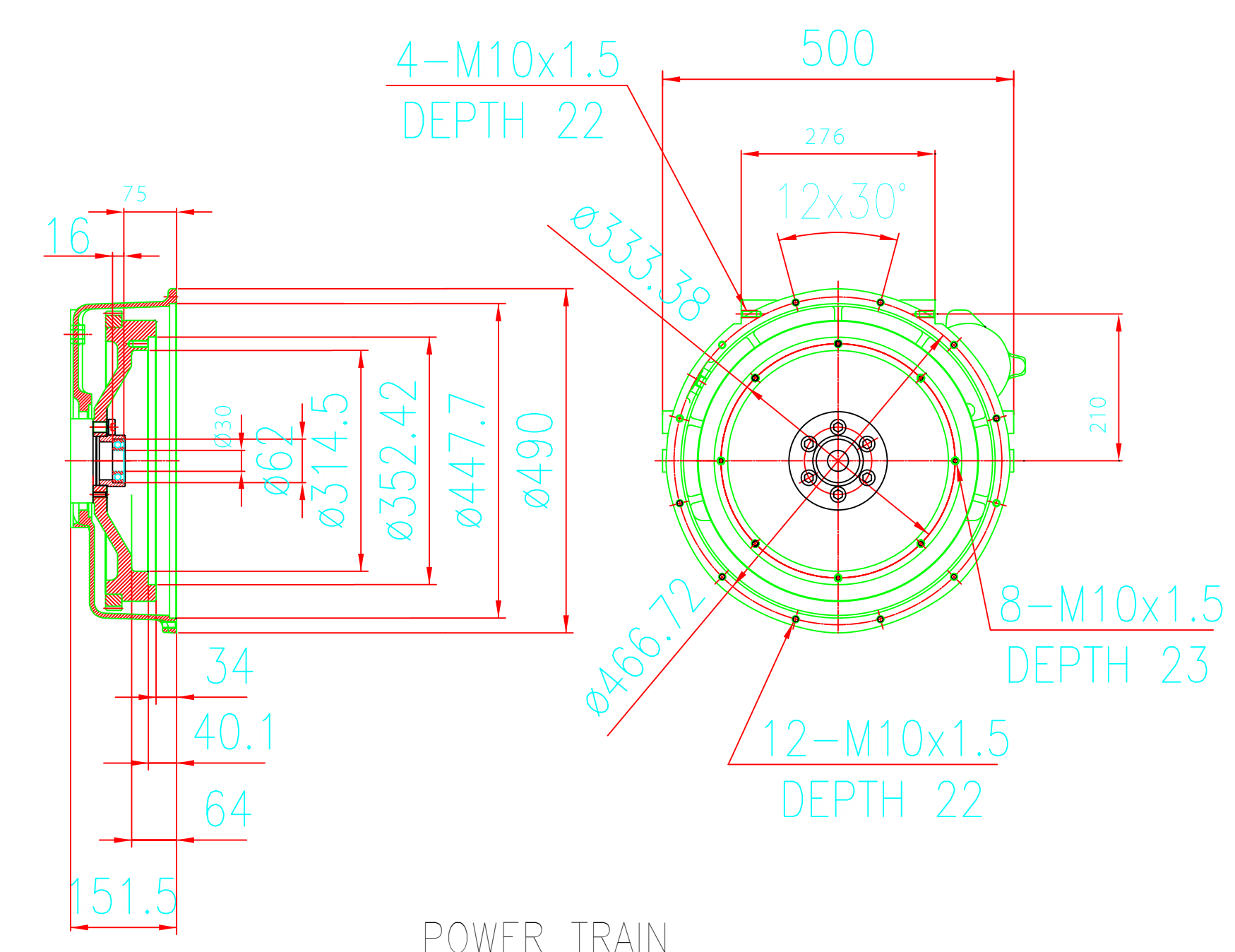
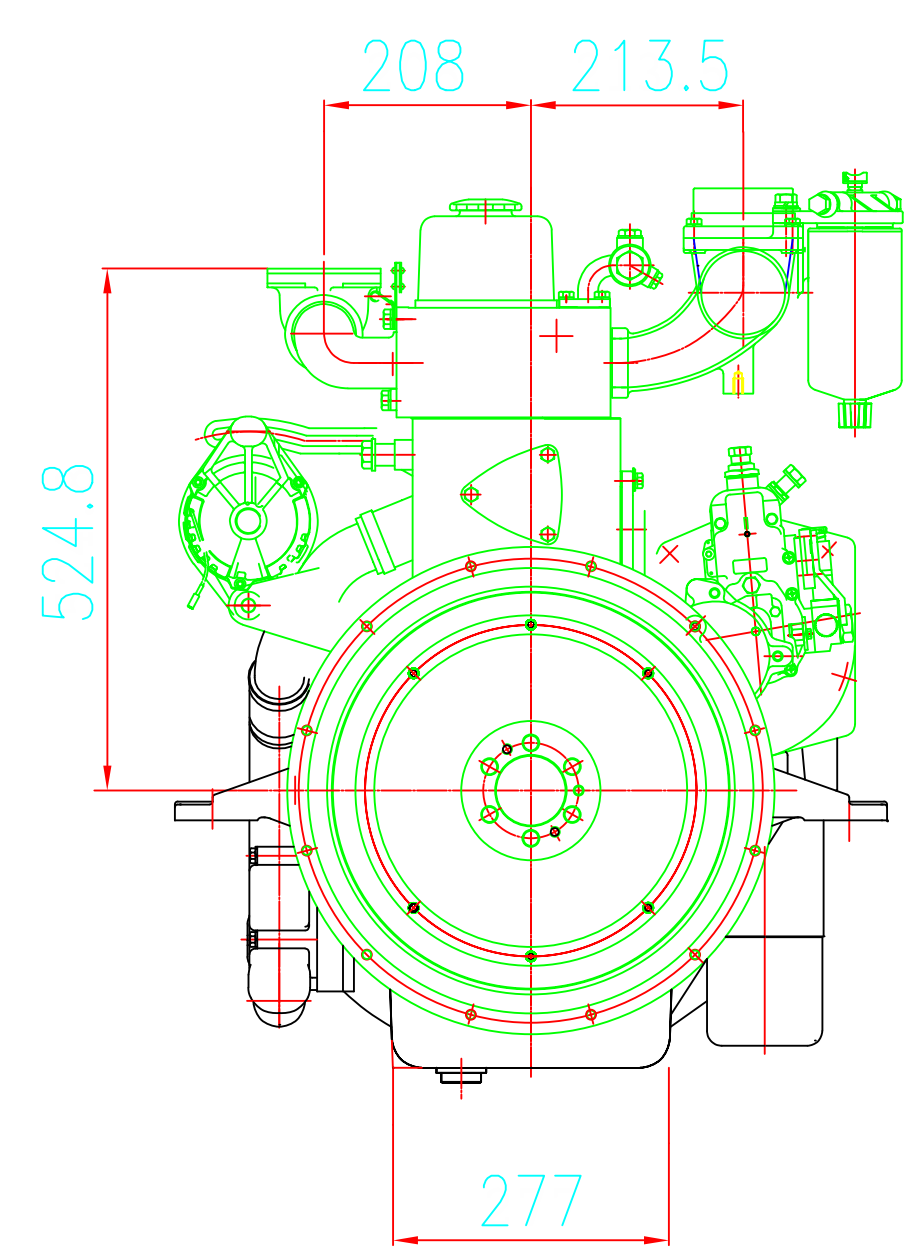
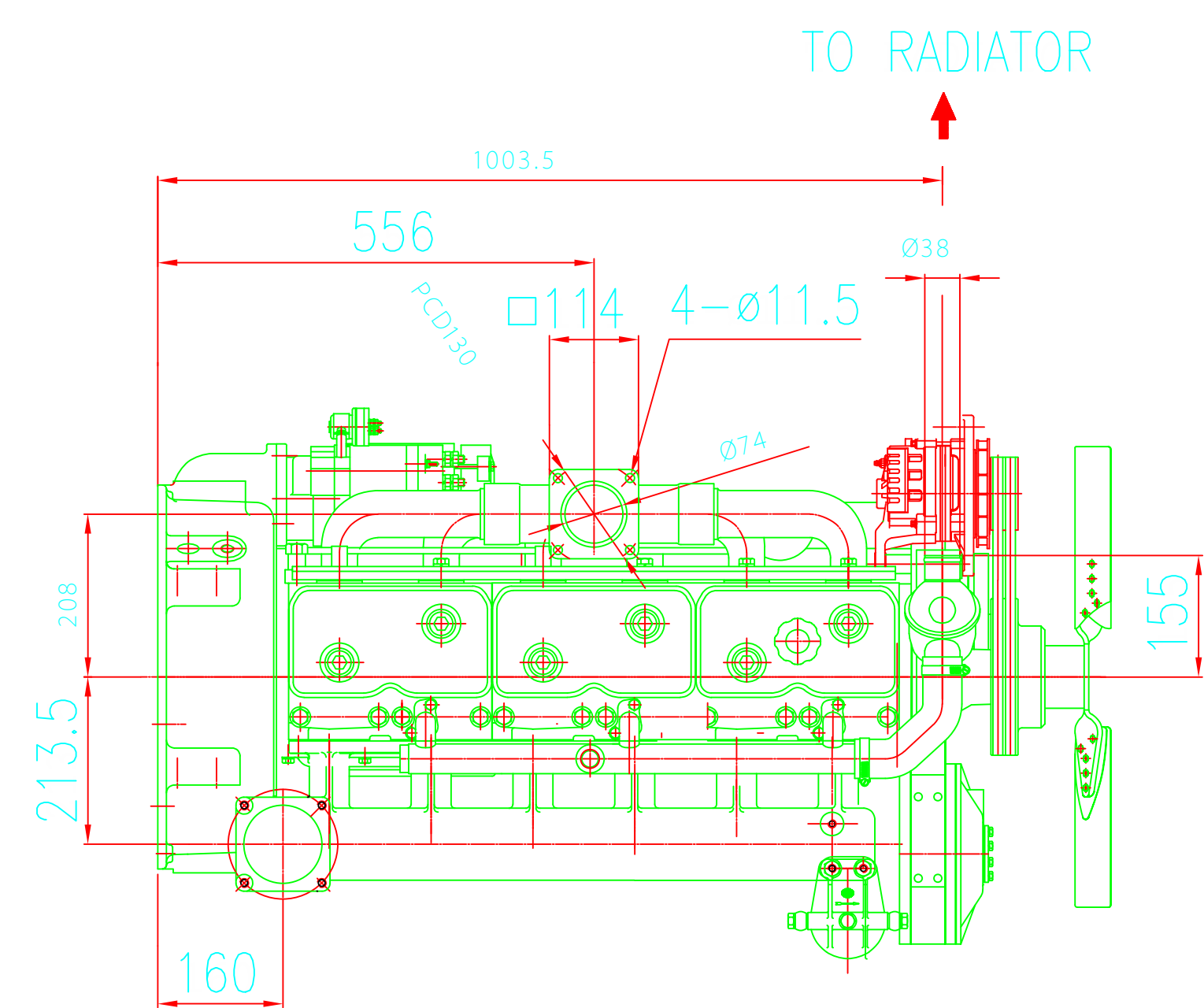
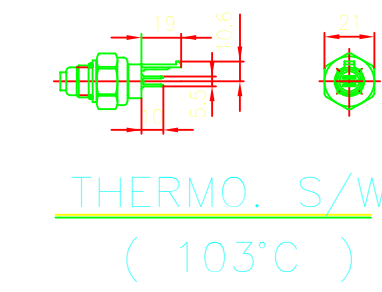
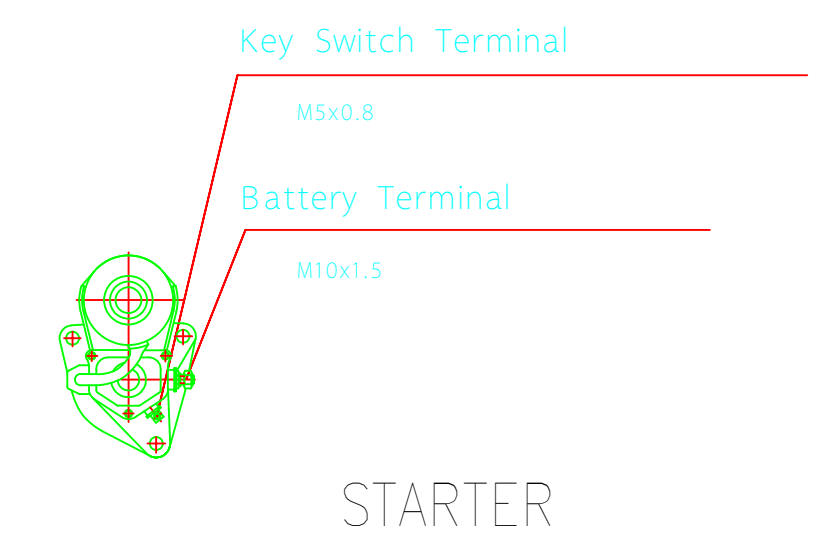
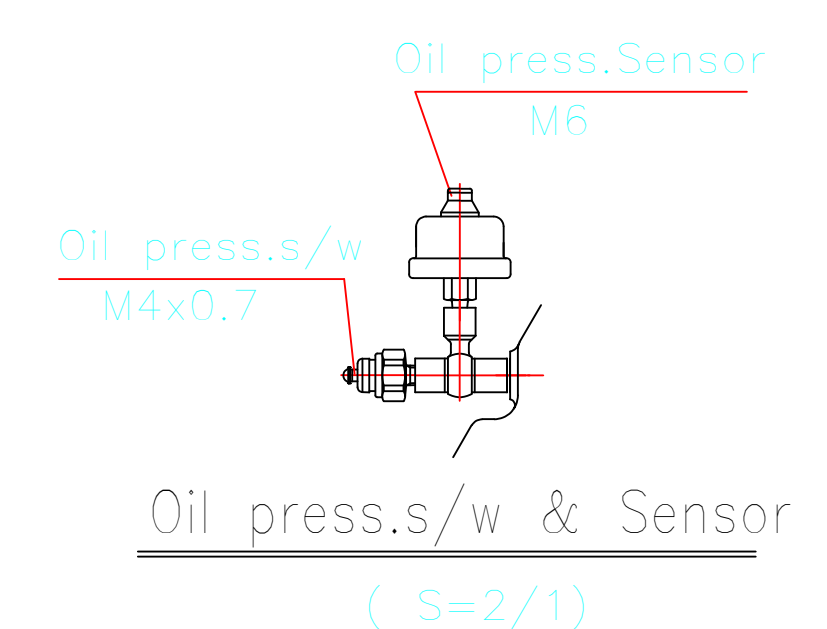
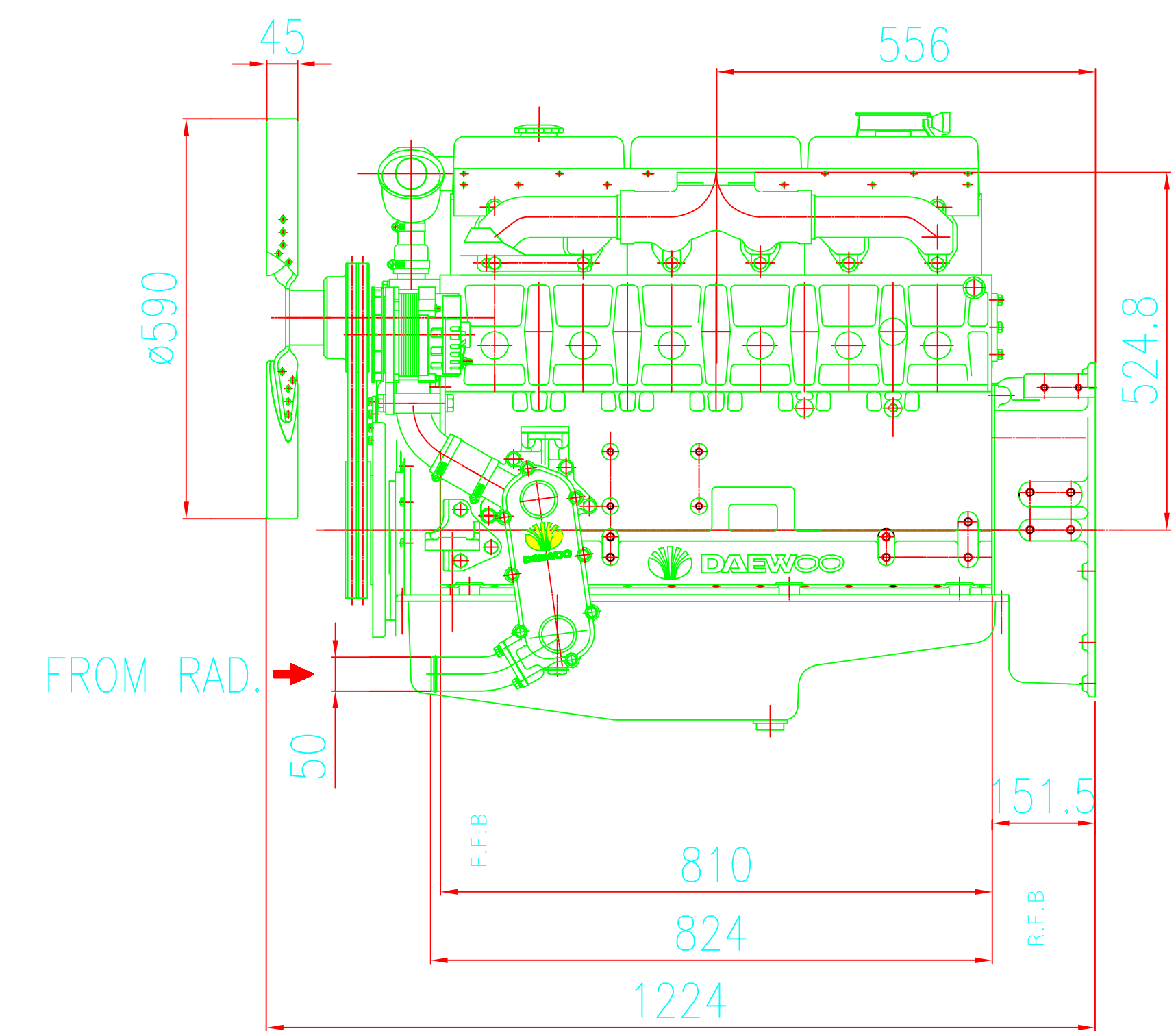
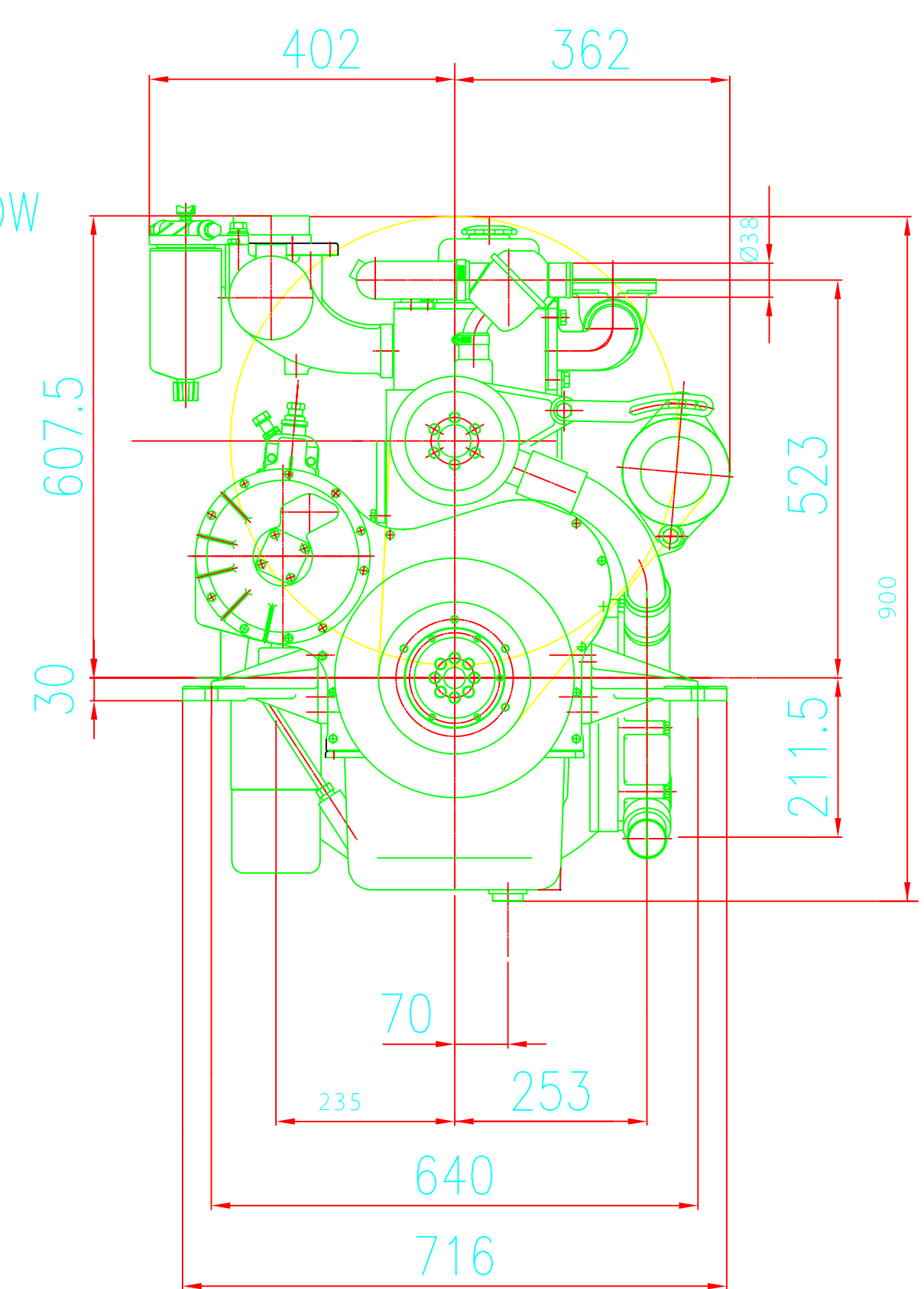
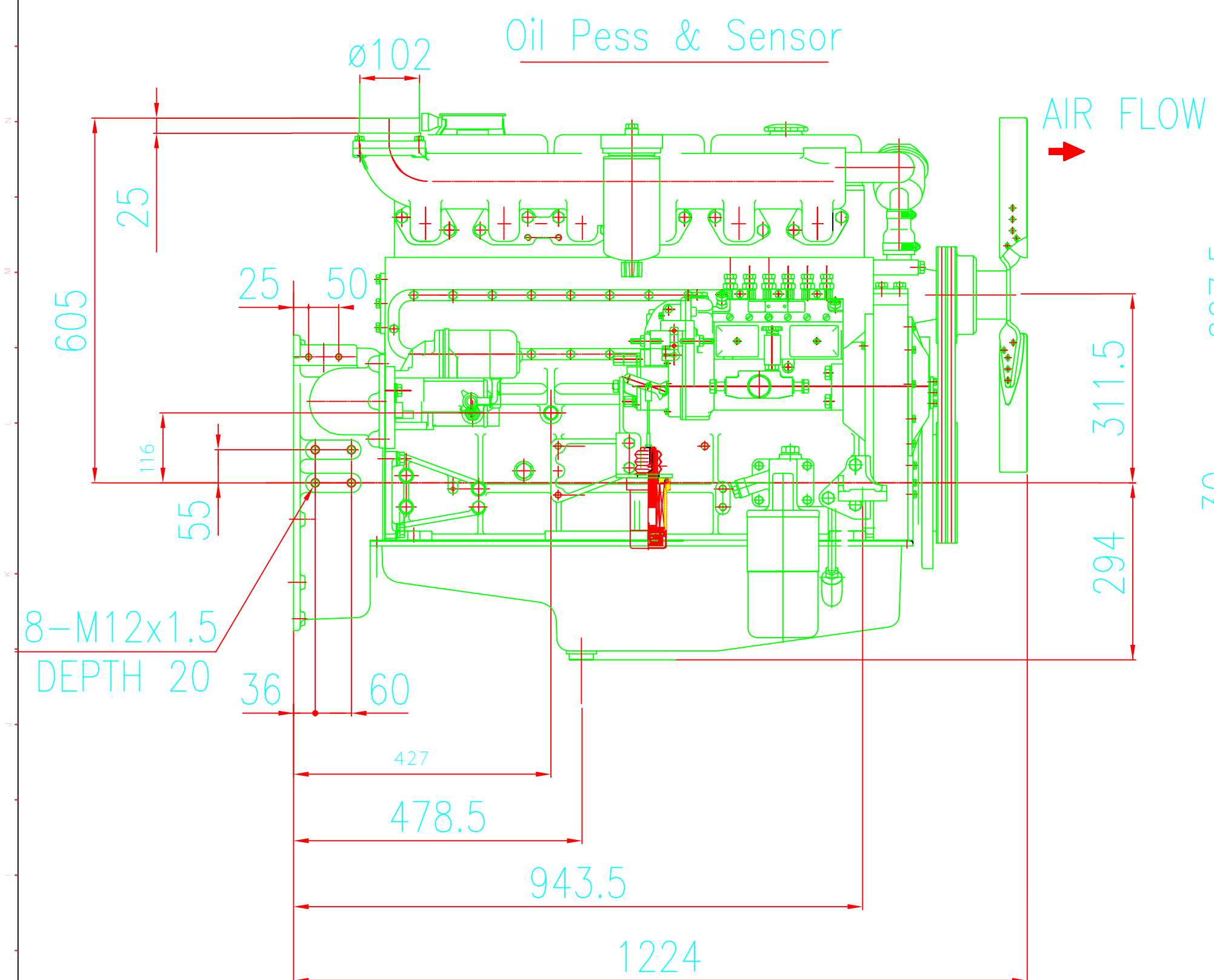

ENGINE SPECIFICATION	
ENGINE MODEL	PU086(D1146)
TYPE	4 CYCLE, WATER COOLED IN-LINE VERTICAL NA DIESEL ENGINE
RATED OUTPUT	158ps/2,200rpm
NO. OF CYL. - BORE x STRC	6 - 111 x 139(mm)
COMBUSTION SYSTEM	DIRECTION INJECTION
FIRING ORDER	1 - 5 - 3 - 6 - 2 - 4
COMP. RATIO	16.7 :1
SWEPT VOLUME	8071 cc
INJ. PUMP	BOSCH IN-LINE"AD" TYPE
GOVERNOR	R.S.V
INJ. NOZZLE OPENING PRESS	220 kg/cm ²
INJ. TIMING	B.T.D.C 18°
ALTERNATOR	24 V x 45A
STARTER	24V x 4.5kW
LUBRICATION OIL CAPACITY	25 liters
COOLING WATER CAPACITY	11 liters
THERMOSTAT OPENING TEMP	OPEN 71°C FULL 85°C
COOLING FAN(STEEL)	Ø590 6BLADES, BLOWER
DRY WEIGHT	Approx. 720 kg

3 4 5

PART NO.	PART NAME	UNIT	QTY	REMARKS
PU086 (D1146)	ENGINE ASS'Y FOR POWER UNIT		1/1	
DES-45310	REV			
DATE	BY	CHK	APP	
2012.11.15	YJ			65.00506-7376
2012.11.15	YJ			